Medbox: A Reliable E-Caregiver Smart System Using Iot

Harish B.R

Department of Electronics and Communication Engineering
Cihan University – Duhok, Kuridsitan Region Iraq

Abstract: Propels in advances of data and correspondence have prompted the development of Internet of Things (IoT). In the present day human services condition, the IoT innovation is accustomed to bring the comfort of doctors and patients, since they are connected to different medicinal regions, for example, constant checking, social insurance administration and patient data administration. Medbox is one of the medicinal services framework in IoT innovation, where the patient is checked ceaselessly utilizing a gathering of lightweight remote sensors and to give customized drug. However the improvement of this IoT innovation over human services frameworks influences the patient security. In this paper, we highlight the significant security necessities and evasion of false cautions. Our point is to acquire a gadget keeping in mind the end goal to accomplish amazing, financially savvy and secure patient-driven checking alongside some potential arrangements.

Keywords: Applications, keen city, ehealthcare, IIoT.

1. INTRODUCTION

Web of things (IoT) is really a digital physical frameworks or a system of systems. It is imagined with gigantic number of things/items and sensors/actuators associated with the web. By means of heterogeneous get to network innovations, for example, radio recurrence distinguishing proof (RFID), remote sensor systems and semantic web administrations, and so forth. The programmed constant information stream is created by associating things with the sensors.

The primary motivation behind utilizing web of things in medicinal application is because of two key angles, 1. To get constant checking over patients, and 2. To check whether the patient is taking after the guidelines or not. IoT makes conceivable to screen progressively, run remote diagnostics, give virtual hands – on support, computerize recharging and dissect use.

In human services framework, IoT includes numerous sorts of sensors (wearable, embedded, and condition) that empowers the general population to appreciate current therapeutic social insurance benefits anyplace and whenever. In the mean time, it likewise extraordinarily enhances the personal satisfaction for a wide range of individuals transcendently matured individuals.

In this paper, we propose a protected IoT based social insurance framework utilizing Med box, which can ensure to effectively achieve the necessities. The rest of the bit of

the paper is sorted out as takes after. In segment II, we display a rundown of existing frameworks which depict a portion of the related work in human services. In area III, we introduce the design of Med box and the subtle elements of the segments utilized as a part of this article. In area IV, at long last the conclusion is examined.

2. EXISTING FRAMEWORKS

Boyi Xu and Li Da Xu [8] proposed a framework to get to huge information in heterogenous arrangement. Phillip [12] gave the significance of IoT in medicinal services applications. Prasanta Gope and Tzonelih Hwang [4] built up an IoT-based current medicinal services framework utilizing Body Sensor Network. The paper [3] gave a nitty gritty review on sorts of sensors. The creator [6] gave the definition and different components of RFID innovation. The creator [12] gave an approach to enhance the nature of wellbeing observing framework.

An IoT based keen framework [5] is executed to gauge the pulse of the cardiovascular patient. The paper [13] proposed a M-Health framework for diabetic patient. Geng Yang, Li Xie, Matti Mantysalo and Xiaolin Zhou [9] gave a wellbeing checking framework, particularly for an elderly people experiencing constant illness. The creator [16] executed an occasion based methods to screen the patient's wellbeing. V.Manju and Abeera V.P [14] conveyed a protected wellbeing IoT utilizing Med box and Zigbee

convention. P.Raga Lavima and Mr.G.Subhramanya Sarma [18] utilized a bio-restorative sensor to gauge the bio-signs and Wi-Fi is utilized to transmit the flag to the recipient. The paper [15] utilizes Med box and sends a SMS ready when the flag is strange.

3. PROPOSED SYSTEM

Our proposed med box depends on clients whoever will have taken medications or prescription on general premise. This med box indicate the pill amount and mean every day. This tells the clients when the pill must be taken. Our shrewd med box is intended for various age gatherings of individuals. The target of the proposed engineering is to give the client appropriate medicinal services utilizing IoT and different supporting advances like body sensor organize, WSN.

3.A. Arduino Uno Board

The Architecture configuration is given in Fig 1.

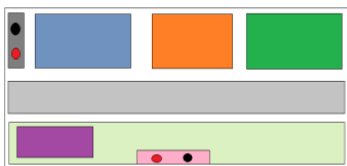

Figure 1. Medbox Top View

It consists of the following parts:

AR ARDUINO Board: It comprises of microcontroller (ATmega) that can be modified to play out a particular undertaking..

BATTERY: It is utilized to give supply voltage (9v) to Arduino board

Clock: It is utilized to show the time, change the time settings, and so on.

Load CELL: It is utilized to quantify the heaviness of a protest put on it. The gave stack cell can make the grade regarding 1kg.

VOLTAGE CONVERTER: It is utilized to open up and digitize the yield from load cell and give it to Arduino board.

SENSOR: It is utilized as a detecting component. At whatever point a question is recognized, the LED associated with the sensor will quit sparkling signifying the interference.

RF MODULE: It is utilized to transmit the advanced information remotely to another Arduino board or whatever other electronic gadgets.

BREADBOARD: It is utilized to associate different electronic components. For case, RF module can be associated with Arduino board utilizing breadboard. It utilizes Arduino board which is give in fig 2.

Arduino is a permit free open source programming that has both programmable microcontroller and programming (IDE) instruments. It can be effortlessly collaborate with catches, LED, engine, speakers, GPS unit, and so forth.



Figure 2. Arduino Board

There are diverse sorts of Arduino in particular Arduino Uno, Arduino Nano, and so forth. For our venture, Arduino Uno is being utilized.

The stick subtle elements is given beneath in fig 3:

GND (3): It is utilized as a short to ground reason.

5V (4) and 3.3V (5): It is utilized for giving force supply. Arduino can acknowledge either 5V or 3.3V supply contingent upon application.

Simple PINS (A0-A5): It can be utilized to give simple flags as info.

Advanced PINS (0-13): It can be utilized to give computerized motions as information.

PWM (8): The pins marked as ~ can likewise be utilized for PWM reason.

AREF (9): It can be utilized at whatever point outside power supply is required.

RESET catch (10): It can be utilized to reset the microcontroller.

Control LED INDICATOR (11): This LED can be utilized to test whether the board is in working condition or not. At the point when the supply is given, the Led must sparkle.

TX-RX LED and PIN (0-1): It is utilized to mean whether transmission or gathering is occurring or not.

VOLTAGE REGULATOR: It changes over the gave voltage to 9V (Arduino's supply voltage).In different words, it directs the voltage.

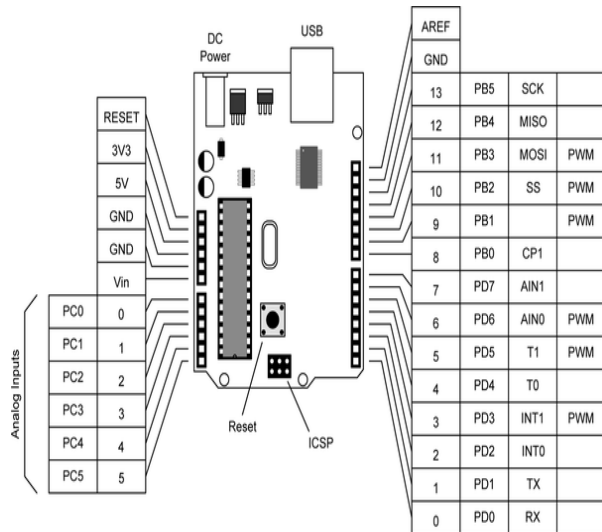

Figure 3. Stick portrayal of Arduino Uno

3.B. IR Sensor

An IR Sensor module (fig 4), is a sensor that transmits and gets infra-red beams when a surface or question is recognized. It is a multipurpose sensor.

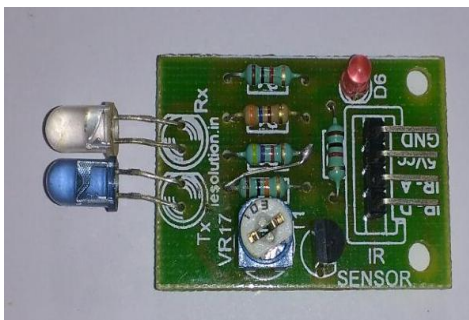

Figure 4. IR Sensor

Transmitter

Transmitter is a light emanating diode (LED) in fig 5, discharges infrared radiations. The radiation produced by it is undetectable to the human eye.

At the point when worked at a supply of 5V, the IR transmitter devours around 3 to 5 mA of current. Infrared transmitters can be regulated to deliver a specific recurrence

of infrared light. The most regularly utilized regulation is OOK (ON – OFF – KEYING) balance.

Collector

Infrared collectors are likewise called as infrared sensors as they distinguish the radiation from an IR transmitter. IR beneficiaries in fig 6, come as photodiodes and phototransistors. Infrared Photodiodes are not the same as expected photograph diodes as they recognize just infrared radiation.

At the point when utilized as a part of an infrared transmitter – recipient mix, the wavelength of the collector ought to coordinate with that of the transmitter.



Figure 5. Transmitter



Figure 6. collector

Standard of Working

When the IR transmitter produces radiation, it achieves the question and a portion of the radiation reflects back to the IR beneficiary. In light of the force of the gathering by the IR recipient, the yield of the sensor is characterized.

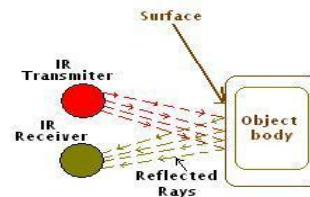

Figure 7. Working of IR sensor

3.C. Minor RTC

It is a battery-controlled check that is incorporated into a microchip in a PC mother load up that monitors the present time notwithstanding when the PC is killed. This IC is a 8

stick gadget utilizing an I2C interface. This microchip stores framework portrayal or ongoing clock, including year, month, date, hours, minutes, and seconds.

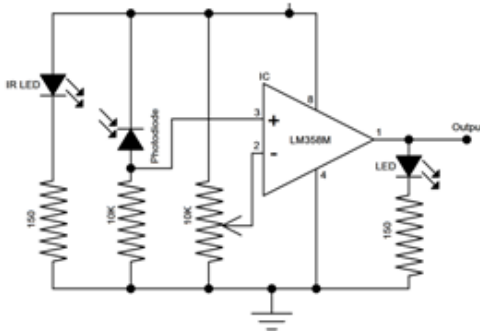
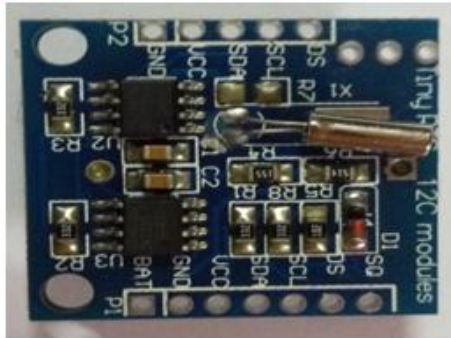

Figure 8. Minor Rtc

WORKING

This IC is a 8 stick gadget utilizing an I2C interface. The DS1307 in fig 9, is a low-control clock/timetable with 56 bytes of battery reinforcement SRAM. In the basic circuit the two information sources X1 and X2 are associated with a precious stone oscillator as the hotspot for the chip. VBAT is associated with positive culture of a 3V battery chip. Vcc energy to the I2C interface is 5V and can be given utilizing microcontrollers. On the off chance that the power supply Vcc is not allowed perused and composes are repressed.

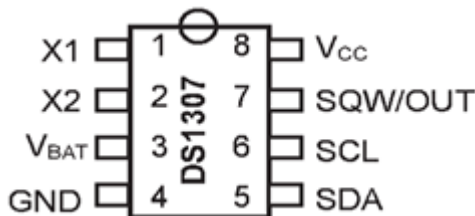

Figure 9. stick depiction of DS1307

By giving a gadget recognizable proof code and an enlist address, we can actualize the START condition to get to gadget. The registers can be gotten to in serial request up to a STOP condition is implemented. START and STOP conditions are required when a gadget needs to build up correspondence with a gadget in the I2C arrange.

As needs be, the accompanying transport conditions have been characterized:

Begin information exchange: An adjustment in condition of information line from high to low, while the clock line is high, it characterizes a START condition.

Stop information exchange: An adjustment in condition of the information line from low to high, while the clock line is high, it characterizes a STOP condition.

Information substantial: The condition of the information line delineates legitimate information when, after a START condition, the information line is steady for the term of the high time of the clock flag. The information hanging in the balance must be changed amid the low time of the clock flag. One clock beat for every piece of information.

3.D. Weight Sensor

It is a gadget used to quantify the heaviness of the part with higher exactness. To execute weight sensor alongside the Arduino two fundamental gadgets are required,

1. Stack cell.
2. HX711 24bit accuracy ADC module.

This Arduino Weight Sensor can distinguish 1kg weight. It in view of HX711, an accuracy 24-bit simple to computerized converter intended for weight scale and mechanical control applications to interface specifically with an extension sensor. This weight sensor brings down the cost of the electronic scale, and in the meantime enhancing the execution and unwavering quality. The interface of this sensor utilizes DFRobot Gravity Interface. The yield embraces reduced terminal that makes the sensor simpler to interface. It's the best decide for electronic devotee to do some little home scale.

1. Load cell

It faculties through the screw opening toward one side settled and the flip side to continue gliding state applying gravity taking after the bearing demonstrated by mark specific consideration must not straightforwardly push the white plastic cover part so as not to harm the sensor.

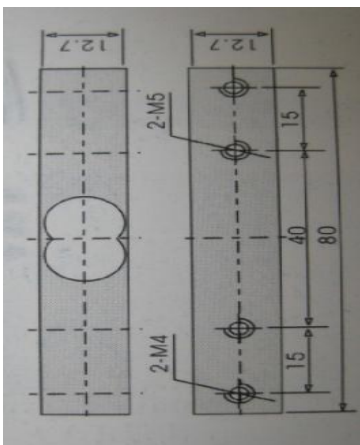

Figure 10a. Load cell Figure 10b. Internal structure

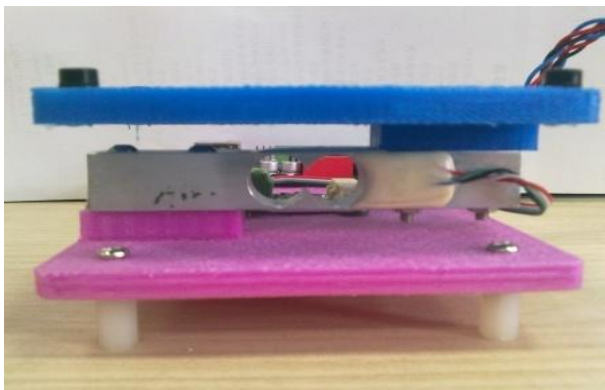

Figure 10c. Settling outline work

Guideline of Working

It takes after the guideline of a Wheatstone connect. At the point when compel is connected toward one side, the resistor twists.

Resistor resistance \sim bowing \sim drive.

This resistance is then changed over into a voltage.

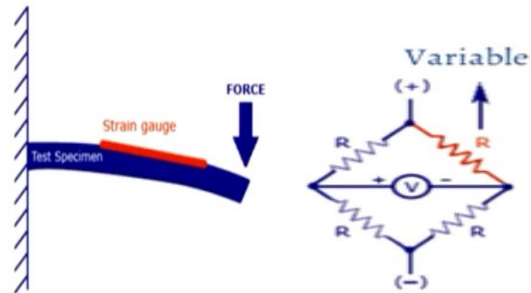

Figure 11a. Applying power Figure 11b. Settling outline work

The strain gage is of many sorts are

A. Quarter connect (contains one variable resistor).

B. Half connect (contains two variable resistors) gives best exactness.

C. Full connect (contains four variable resistors) gives better precision and minimum mistake.

2. HX 711

HX711 in fig 12, is an exactness 24-bit simple to-computerized converter (ADC) intended to measure scales and modern control applications to interface straight forwardly with an extension sensor.

The info multiplexer chooses either Channel An or B differential contribution to the low-commotion programmable pick up intensifier (PGA). Channel A can be modified with a pick up of 128 or 64, relating to a full-scale differential information voltage of $\pm 20\text{mV}$ or $\pm 40\text{mV}$ individually, when a 5V supply is associated with AVDD simple power supply stick. Channel B has a settled pick up of 32.

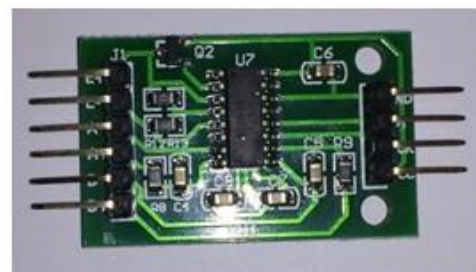

Figure 12. HX711

Components of HX711

- ✓ Two selectable differential info channels.
- ✓ On-chip dynamic low commotion PGA with selectable pick up of 32, 64 and 128.
- ✓ On-chip control supply controller for load-cell and ADC simple power supply.
- ✓ On-chip control on-reset.
- ✓ Simultaneous 50 and 60Hz supply dismissal.
- ✓ Current utilization including on-chip simple control supply controller:
- ✓ normal operation < 1.5mA, shut down < 1uA
- ✓ Operation supply voltage extend: 2.6 ~ 5.5V.
- ✓ Operation temperature extend: - 40 ~ +85°C.

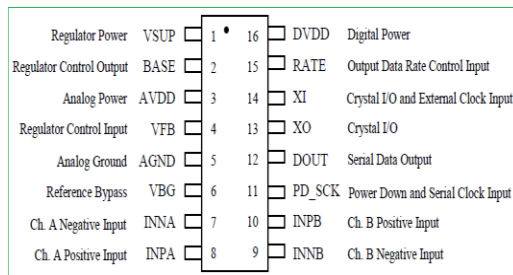

Figure 13. Pin Diagram of HX711

3.E. LCD Display

LCD, an acronym for Liquid Crystal Display reformed the current show innovation with its minimization and adaptability. A 16x2 LCD show in fig 15, is extremely fundamental module and is regularly utilized as a part of different gadgets and circuits. These modules are favored more than seven portion and other multi section LEDs. The reasons being: LCDs in fig 14, are sparing; effectively programmable; have no constraint of showing extraordinary and even custom characters (not at all like in seven fragments), movements et cetera.

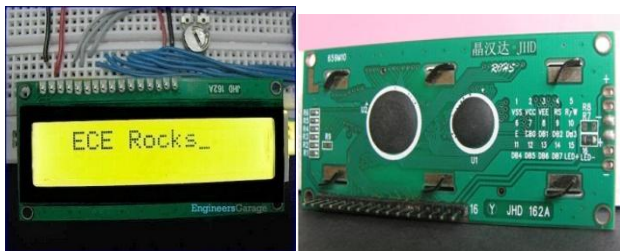

Figure 14. LCD show

A 16x2 LCD appeared in the picture underneath can show 32 characters with 16 characters in each line. It is competent to show any character with ASCII esteems going from 0 to 255.

In this LCD each character is shown in 5x7 pixel grid. This LCD has two registers, to be specific, Command and Data. The charge enroll stores the summon guidelines given to the LCD. A charge is a guideline given to LCD to do a predefined errand like instating it, clearing its screen, setting the cursor position, controlling showcase and so on. The information enroll stores the information to be shown on the LCD. The information is the ASCII estimation of the character to be shown on the LCD.

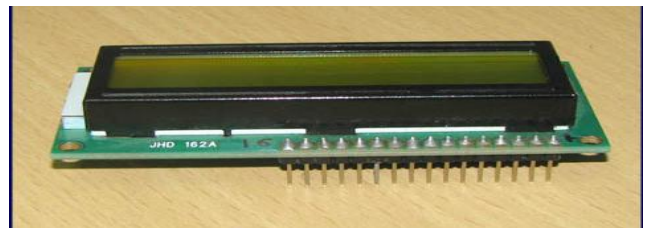

Figure 15. 16*2 LCD SHOW

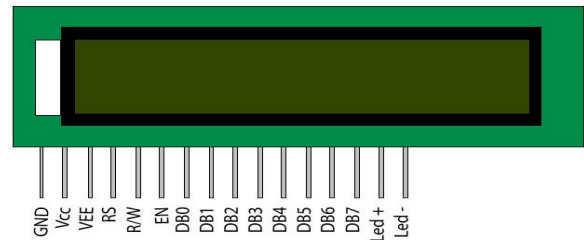

Figure 16. Stick portrayal of LCD show

Focal points

1. Very conservative, thin and light, particularly in examination with cumbersome, substantial CRT shows.
2. Low power utilization. Contingent upon the set show splendor and substance being shown, the more established CCFT illuminated models commonly utilize not as much as half of the power a CRT screen of a similar size review region would utilize, and the advanced LED illuminated models regularly utilize 10–25% of the power a CRT screen would utilize.
3. Little warmth discharged amid operation, because of low power utilization.
4. No geometric contortion.

Burdens

1. Limited survey point in some more established or less expensive screens, bringing about shading, immersion, complexity and brilliance to differ with client position, even inside the planned review edge.
2. Uneven backdrop illumination in a few (for the most part more seasoned) screens, bringing about shine bending, particularly toward the edges.
3. Black levels may not be as dull as required in light of the fact that individual fluid gems can't totally obstruct the majority of the backdrop illumination from going through.
4. Display movement obscure on moving articles brought on by moderate reaction times (>8 ms) and eye-following on a specimen and-hold show, unless a strobing backdrop illumination is utilized. In any case, this strobing can bring about eye-strain.

Highlights

- ✓ Cost viable and Energy productive.
- ✓ Space economy, Lighter weight.
- ✓ Reduced radiation and has better life expectancy.
- ✓ Less eye fatigue.
- ✓ Improved picture quality/differentiate.
- ✓ Easy alternatives and elements.

3.F. GSM MODULE 900A

This is a ultra minimal and solid remote module. The SIM900A is a total Dual-band GSM/GPRS arrangement in a SMT module which can be installed in the client applications enabling you to profit by little measurements and savvy arrangements.

Including an industry-standard interface, the SIM900A conveys GSM/GPRS 900/1800MHz execution for voice, SMS, Data, and Fax in a little frame calculate and with low power consumption. With a modest setup of 24mm x 24mm x 3 mm, SIM900A can fit all the space necessities in your applications, particularly for thin and minimal request of outline.

Determination

PCB size	71.4mm* 66.0mm* 1.6mm
Indicators	PWR, status LED, net LED
Power supply	5v
Communication Protocol	UART
RoHS	yes

The Status of the NETSTATUS LED

Status	Description
off	SIM900 is not running 64ms On/800ms
off	SIM900 not registered the network
64ms On/3000ms Off	SIM900 registered to the network
64ms On/3000ms Off	GPRS communication is established

Highlights

- ✓ Quad-Band 850/900/1800/1900 MHz .
- ✓ Dual-Band 900/1900 MHz.
- ✓ Control by means of AT charges (GSM 07.07 ,07.05 and SIMCOM upgraded AT Commands).
- ✓ Low control utilization: 1.5mA(sleep mode).
- ✓ Operation temperature: - 40°C to +85 °C .
- ✓ Class (1 W @ 1800/1900MHz).
- ✓

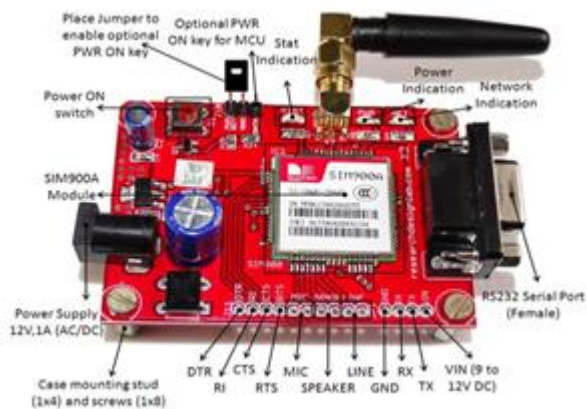

Figure 17. portrayal of GSM module

The result of the solid e-guardian framework is for informing the client (through application) about his/her drugs on time .

Checking the patient movement, regardless of whether the correct medication has been taken at the perfect time and in right amount. Tell the patient (through application) if there should be an occurrence of running shy of provisions before close by , to maintain a strategic distance from non accessibility of supplements.

Utilization of med box are

- ✓ An proficient and dependable guardian for individuals who are to take solutions on time.
- ✓ Medbox can without a doubt fill in as a proficient framework for observing the turn away sporadic circumstances and advise them before close by.
- ✓ To abstain from skipping of standard solution allow because of our bustling timetable.
- ✓ Applicable to all people regardless of age.
- ✓

4. CONCLUSION

In this way the framework proposed will go about as a proficient, solid e-Caregiver incorporating the upsides of IoT sensor bury organizing, android application and unambiguously be a shrewd framework for everyday application and a dependable utilization.

REFERENCES

- [1] Luca Catarinucci, Danilo de Donno, Luca Mainetti, Luca Palano, Luigi Patrono, Maria Laura Stefanizzi, and Luciano Tarricone , (2015) , 'An IoT-Aware Architecture for Smart Healthcare Systems' , In IEEE Internet Of Things Journal, Vol. 2, No. 6, December.
- [2] Ajmal Sawand, Soufiene Djahel, Zonghua Zhang, Farid Naït-AbdesselamA) Paris Descartes University, Paris, FranceB) University College Dublin, Dublin, IrelandC) TELECOM Lille, France , (2015) , 'Toward Energy-Efficient and Trustworthy eHealthMonitoring System', Selected Papers From IEEE/CIC ICC 2014,China Communications January.
- [3] CHEN Xican, Woogeun RHEE, WANG ZihuaInstitute of Microelectronics, Tsinghua University, Beijing 100084,China, (2015) , ' Low Power Sensor Design for IoT and Mobile Healthcare Applications' , In Communication IC,China Communications , May.
- [4] Prosanta Gope and Tzonelih Hwang , (2016) , ' BSN-Care: A Secure IoT-Based Modern Healthcare System Using Body Sensor Network ' , In IEEE Sensors Journal, Vol. 16, No. 5, March 1.
- [5] Kinshuk U. Nigam, Abhinee A. Chavan, Sumit S. Ghatule, Vaishali M. Barkade , (2016) , ' IOT-BEAT: An Intelligent Nurse for the cardiac Patient ' , In International Conference on Communication and Signal Processing, April 6-8, India.
- [6] Sara Amendola, Rossella Lodato, Sabina Manzari, Cecilia Occhiuzzi, and Gaetano Marrocco, (2014) , ' RFID Technology for IoT-Based Personal Healthcare in Smart Spaces' , IEEE Internet Of Things Journal, Vol. 1, No. 2, April.
- [7] Yuan Zhang, Senior Member, IEEE, Limin Sun, Member, IEEE, Houbing Song, Senior Member, IEEE, and Xiaojun Cao, Member, IEEE, (2014) , ' Ubiquitous WSN for Healthcare: Recent Advances and Future Prospects' , IEEE Internet Of Things Journal, Vol. 1, NO. 4, August.
- [8] Boyi Xu, Li Da Xu, Senior Member, IEEE, Hongming Cai, Cheng Xie, Jingyuan Hu, and Fenglin Bu, (2014) , ' Ubiquitous Data Accessing Method in IoT-BasedInformation System for Emergency Medical Services' , IEEE Transactions On Industrial Informatics, Vol. 10, No. 2, May.
- [9] Geng Yang, Li Xie, Matti Mäntysalo, Xiaolin Zhou, Member, IEEE, Zhibo Pang, Li Da Xu, Senior Member, IEEE, Sharon Kao-Walter, Qiang Chen, and Li-Rong Zheng, Senior Member, IEEE, (2014) , 'A Health-IoT Platform Based on theIntegration of Intelligent Packaging, Unobtrusive Bio-Sensor, and Intelligent Medicine Box' , IEEE Transactions On Industrial Informatics, Vol. 10, No. 4, November.
- [10] Debiao He and Sherali Zeadally, (2015) , 'An Analysis of RFID Authentication Schemes for Internet of Things in Healthcare Environment Using Elliptic Curve Cryptography' , IEEE Internet Of Things Journal, Vol. 2, No. 1, February.
- [11] S.M. Riazul Islam, M. Nazim Uddin, and Kyung Sup Kwak, (2016) , 'The IoT: Exciting Possibilities for Bettering Lives' , IEEE Consumer Electronics Magazine, April.
- [12] Phillip A. Laplante, Pennsylvania *State University* , Nancy Laplante, *Widener University*, ' The Internet of Things in Healthcare Potential Applications and Challenges' , Irena Bojanova, US National Institute of Standards and Technology, irena.bojanova@computer.org.

[13] Shih-Hao Chang, Rui-Dong Chiang, Shih-Jung Wu, and Wei-Ting Chang, *Tamkang University of Taiwan*, (2016), 'A Context-Aware, Interactive M-Health System for Diabetics', Published by the IEEE Computer Society, May/June.

[14] Sonam V. Maju & Abeera V.P, (2015), 'A Secure Health IoT for Patient Monitoring with Intelligent Medicine Box', *International Journal of Electronics Communication and Computer Engineering* Volume 6, Issue (5) Sept., NCRTCST, ISSN 2249-071X.

[15] Gipsa Alex, Benitta Varghese, Jezna G Jose, AlbyMol Abraham, 'A Modern Health Care System Using IoT and Android', Gipsa Alex et al. / *International Journal on Computer Science and Engineering (IJCSE)*.

[16] Lei Tang, Xingshe Zhou, Zhiwen Yu, Senior Member, IEEE, Yunji Liang, Daqing Zhang, and Hongbo Ni, (2011), 'MHS: A Multimedia System for Improving Medication Adherence in Elderly Care', *IEEE Systems Journal*, Vol. 5, No. 4, December.

[17] Li Xie, Geng Yang, Matti Mäntysalo, Lin-Lin Xu, Fredrik Jonsson, and Li-Rong Zheng, Member, IEEE, (2012), 'Heterogeneous Integration of Bio-Sensing System-on-Chip and Printed Electronics', *IEEE Journal On Emerging And Selected Topics In Circuits And Systems*, Vol. 2, No. 4, December.

[18] P. Raga Lavimal, Mr. G. Subhramanya Sarma, (2015), 'AN IOT BASED INTELLIGENT MEDICINE BOX', *International Journal of Computer Science and Mobile Computing IJCSMC*, Vol. 4, Issue. 10, October.